

Tracer® Electronic Switching Flowmeter

with FCI (Fluid Characteristic Indication)

Operating Instructions

General

The Tracer Electronic Switching Flowmeter provides:

- ◆ 0 to 5V or 0 to 10V Selectable Flow Output
- ◆ 0 to 5V or 0 to 10V Selectable Temperature Output
- ◆ 1A, 30VAC/42VDC Programmable Switch for high or low temperature and/or flow
- ◆ Flow Rate Display in gallons per minute (gpm) or liters per minute (lpm)
- ◆ Temperature Display (°F or °C)
- ◆ BTU's per Minute Display
- ◆ Fluid Characteristic Indication (Turbulent Flow or "TFLOW" on display)

BTU Basics

To obtain the most accurate BTU calculation, use the Tracer to measure the supply side water temperature (in °F) before installing the Tracer in a cooling water return line.

BTU's per minute calculation is based on the increase in water temperature times the flow rate. The Tracer Electronic Flowmeter calculates this information based on supply side temperature entered manually. Due to inherent differences in most thermometers, the most accurate BTU calculation will result from using the same thermometer (inside the Tracer) to measure supply and return line temperatures. Record the supply side temperature and enter it using the "Set BTU/m Input Temperature" instructions on page 3.

Turbulent Flow

"TFLOW" notification appears on the display when Turbulent Flow is present inside the Tracer Flowmeter. Turbulent flow is the mixing and swirling of water inside a cooling line that provides optimum heat transfer. Water flow rate greater than the point of Turbulent Flow does not provide faster cooling.

Turbulent flow tracking allows technicians to apply mathematical cooling principles to all machines in a water system. Visit the Technical Documents section of www.smartflow-usa.com for a detailed discussion of Turbulent Flow.

U.S. Patent Pending



Application

Liquid running through the Tracer flowmeter should be free of metal shavings. Metal particles will attach to the sensing magnet in the impeller, causing the unit to require extra maintenance.

Specifications

Flow

Size [NPT(F)]	Range (gpm)	Range (lpm)
3/8"	0.5 to 8	0 to 30
3/4"	2.0 to 20	8 to 76
1"	3.0 to 30	11 to 114
1-1/2"	6.5 to 60	25 to 228
2"	10.0 to 110	38 to 418

Accuracy±5% of Full Range

Repeatability±3% of Full Range

Environment

Tracer construction is water resistant, but the electronics housing is not submersible.

Temperature

Operating Range.....32 to 180°F (0 to 82°C)

Accuracy.....±2% of Display Value

Repeatability.....±1% of Display Value

Component Materials

Body (3/8" model).....Nickel-Plated Brass

Body (3/4" thru 2").....Anodized Aluminum

.....Stainless Steel (optional)

Back Cover(3/8" only) ..Polysulfone

Impeller.....Nylon 6/12

Magnet.....Neodymium

Shaft.....18-8 Stainless Steel

Electronics CoverNylon 6/6

Cable.....9-Conductor, 24AWG

Operating

Internal RelaySPDT 1A, 30VAC/42VDC

Power Required8 to 28VDC

Maximum Pressure.....100psi (7bar)

burger & brown engineering, inc.

4500 E 142nd Street • Grandview, MO 64030 • Tel. (816) 878-6675 • Fax (816) 878-6683 • www.smartflow-usa.com

Installation Instructions

Best flow rate accuracy is achieved when plumbing a straight run of pipe equal to 10 pipe diameters on the inlet side of the Tracer flowmeter and a straight run of pipe equal to 5 pipe diameters on the outlet side of the flowmeter.

Use appropriate pipe sealant to prevent leakage on inlet and outlet sides of the flowmeter. The Tracer flowmeter can be installed in any orientation with the flow direction from either end of the flowmeter. Attach the power and switching connections to the bare wires of the cable according to the chart at right. Individual wires are 24AWG stranded copper. Attach 8 to 28VDC power to the unit for correct operation. Power supply other than 8 to 28VDC may damage the electronics!

In normal operation, the relay is energized. If power to the unit is lost, or if unit is turned off, relay state changes to signal an alarm.

Wire Color	Function
Black	DC Ground (Ground for Analog Output)
Yellow	+DC Input (8 to 28VDC)
Red	Not used
Blue	Not used
Orange	Flow Analog Voltage Output (+)
Violet	Temp. Analog Voltage Output (+)
Green	Relay Common
Brown	Relay Normally Closed
Gray	Relay Normally Open

Operating Instructions

When power is applied to the Tracer flowmeter, the software version and the Tracer Unit Code (EP) will appear sequentially. Then the screen will be blank. Press ON to activate the display.

There are three modes of operation for the Tracer Electronic Flowmeter: User Mode, Setup Mode, and Calibration Mode. **User Mode** displays all available process information. **Setup Mode** configures the flowmeter for unit selection (°F, °C, lpm, and gpm) and switching set points. Setup Mode also allows you to enter the information required to calculate BTU's per Minute.

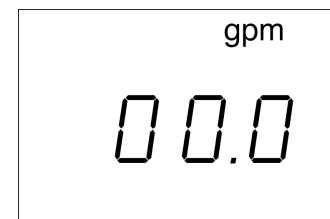

Figure 1

User Mode

After pressing ON, press Δ or ∇ buttons repeatedly to scroll continuously through displays of flow rate, temperature and BTU/m. BTU/m will not display until activated using the Setup Mode on page 3.

View Flow Rate



Press ON. Flow rate and units (gpm or lpm) will be displayed. See Figure 1.

View Temperature



Press Δ . Temperature and units (°F or °C) will be displayed. See Figure 2.

View BTU/m (not visible until activated)



Press Δ . BTU's and units will be displayed. See Figure 3. To activate, enter Setup Mode, and follow instructions to set input temperature found on page 3.

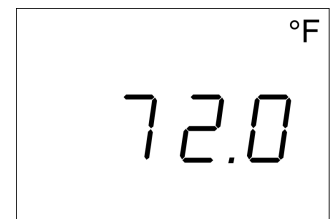

Figure 2

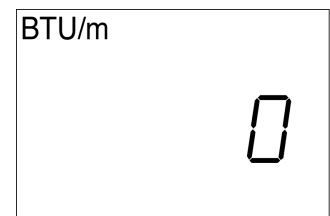
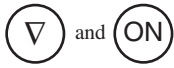

Figure 3

Setup Mode

Setup Mode allows the user to select English or Metric units, input BTU/m inlet temperature, and set auto shut-off time. Δ and ∇ keys scroll through all options inside each display selection.

Enter Setup Mode



The display must be off to enter Setup Mode. Press and hold ∇ , then press ON. Flow rate units plus "Unit" and "SETUP" will be displayed. See Figure 4.

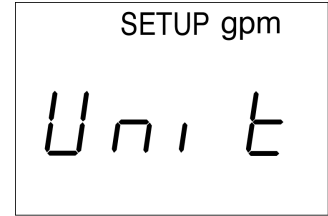
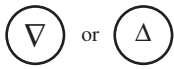

Figure 4

Select Flow Rate Units



Press ∇ or Δ to change units to gpm or lpm. Press ON when the desired unit is displayed. See Figure 4. Setup Mode will continue unless you exit.

Exit Setup Mode

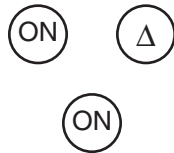

Press ON repeatedly until the display reads "end", then press Δ . See figure 5. The display will read "off", then press ON and the unit will return to user mode.

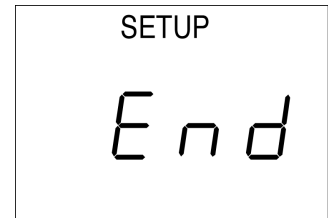
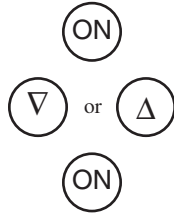

Figure 5

Select Temperature Units



Enter Setup Mode (above). Press ON repeatedly until the display shows "°F" or "°C" in the upper right corner and "unit" in the center. See Figure 6. Press ∇ or Δ to change units. Press ON when desired unit is displayed. Setup Mode will continue unless you exit.

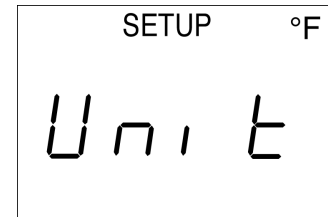
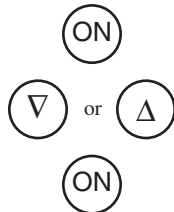

Figure 6

Set BTU/m Input Temperature



Enter Setup Mode (above). Press ON repeatedly until the display shows "BTU/m" in the upper left corner. See Figure 7. Press ∇ or Δ to change input temperature (40 to 220°F or 4.4 to 104.4°C). Press ON when desired unit is displayed.

Note: If you set the temperature input to less than 40°F or 4.4°C, the display will show "off" and BTU/m display will deactivate.

Setup Mode will continue unless you exit.



Figure 7

Reactivate BTU/m

Follow the instructions to set (above) and press ∇ or Δ to display a value instead of "off", and press ON to set.

Switch Set Points

All switch set points are turned off when shipped from the factory. The switch actuates when sensed value(s) fall below low level set point(s) and/or sensed values rise above high level set point(s). The switch returns to normal state when the process fluid reaches programmed flow and/or temperature conditions. There is a 2 second delay to prevent switch chatter. Any or all of the switches may be disabled or enabled at any time. An internal programming check prevents conflicting low and high switch values. **Always set the flow switching points using the same units as normal operating units.**

Set Lo Limit Flow Switch Point

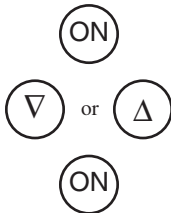
 Enter Setup Mode (see page 3). Press ON repeatedly until the display shows “gpm” or “lpm” in the upper right corner and “LO L” in the center. See Figure 8. Press ∇ or Δ to set the flow rate at which the Normally Open switch contact will close. Press ON when desired value is displayed. To turn off this set point, press and hold ∇ until the display shows “OFF”. Setup Mode will continue unless you exit.

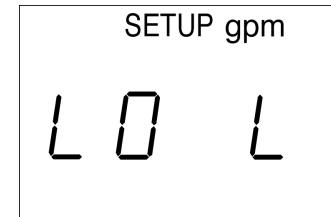
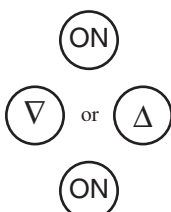

Figure 8

Set Hi Limit Flow Switch Point

 Enter Setup Mode (see page 3). Press ON repeatedly until the display shows “gpm” or “lpm” in the upper right corner and “HI L” in the center. See Figure 9. Press ∇ or Δ to set the flow rate at which the Normally Open switch contact will close. Press ON when desired value is displayed. To turn off this set point, press and hold Δ until the display shows “OFF”, and press ON to set. Setup Mode will continue unless you exit.

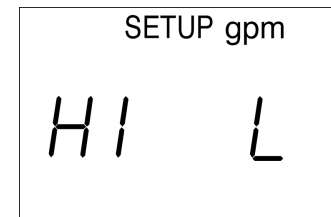
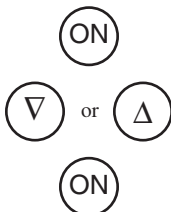

Figure 9

Set Lo Limit Temperature Switch Point

 Enter Setup Mode (see page 3). Press ON repeatedly until the display shows “°F” or “°C” in the upper right corner and “LO L” in the center. See Figure 10. Press ∇ or Δ to set the temperature at which the Normally Open switch contact will close. Press ON when desired value is displayed. To turn off this set point, press and hold ∇ until the display shows “OFF”. Setup Mode will continue unless you exit.

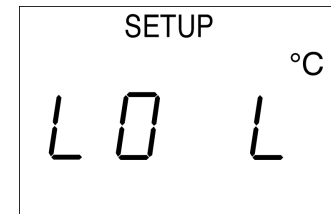
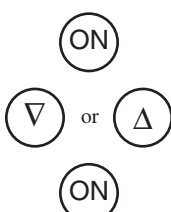

Figure 10

Set Hi Limit Temperature Switch Point

 Enter Setup Mode (see page 3). Press ON repeatedly until the display shows “°F” or “°C” in the upper right corner and “HI L” in the center. See Figure 11. Press ∇ or Δ to set the flow rate at which the Normally Open switch contact will close. Press ON when desired value is displayed. To turn off this set point, press and hold Δ until the display shows “OFF”, and press ON to set. Setup Mode will continue unless you exit.

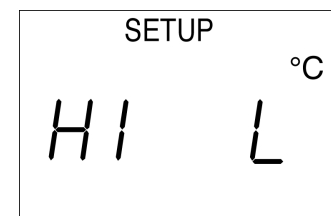
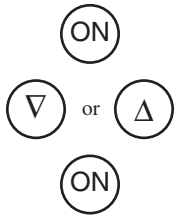

Figure 11

Set Flow Rate Display Filter



The Tracer flowmeter responds to flow changes very rapidly. The impeller changes speed as the water is swirling and mixing while passing through the meter. The filter program stabilizes the display reading for the meter by averaging readings from the impeller. A larger filter number results in a smoother flow rate display. The filter program causes a delay in the flow reading upon start-up while performing the initial averaging function. Enter the Setup Mode (see page 3). Press ON repeatedly until the display reads "Filt" (see figure 12) Press ∇ or Δ to change the amount of filtering (1 to 32). Press ON when desired filter is displayed. Press ∇ less than 1 to turn off the filter.

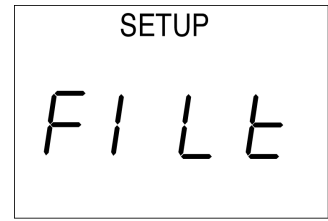
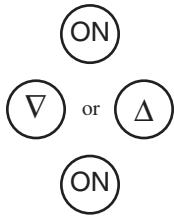

Figure 12

Change Cooling Line Size (Turbulent Flow)



Enter Setup Mode (see page 3). Press ON repeatedly until the display shows "PIPE" (see Figure 13). Press ∇ or Δ to change cooling line size. Available sizes are:

- 0.250
- 0.375
- 0.750
- 1.000
- 1.500
- 2.000

Turbulent Flow display "TFLOW" and calculation are adjusted automatically based on process temperature and pipe size.



Figure 13

Select Relay Action to Set Points or Turbulent Flow

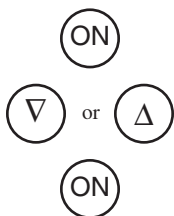

Relay can be set to switch on user programmed set points or on Turbulent Flow. Enter Setup Mode (see page 3) Press ON repeatedly until the display shows "rELY" (see Figure 14). Press ∇ or Δ to change relay action to "ALARM" or "TFLOW". Alarm settings are programmed per instructions on page 4 and are held in memory if "TFLOW" setting is used. Factory default setting is "ALARM"

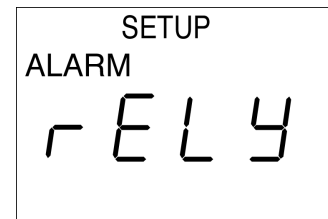





Figure 14

Analog Output Options

Output Voltage for flow and temperature are set independently. 0 to 5V or 0 to 10V output is selectable for flow or temperature. The upper end of the effective flow range is also user-definable to give a more accurate flow and temperature reading over the voltage output range. For Example: In a 1" cooling line you are using only half of the flow range. The Tracer flowmeter can be set for 10V output at 15gpm instead of 30gpm to provide more precise voltage output.

 or 

Select Flow Voltage Output

Enter Setup Mode (see page 3). Press ON repeatedly until the display shows “AO F” (Analog Output Flow) in the center. See Figure 15. Press ∇ or Δ to set 5 or 10 Volts as the upper end of the output range. Press ON when desired value is displayed.

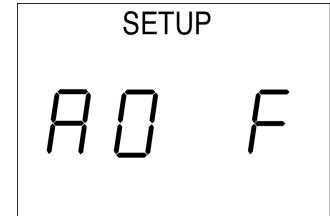





Figure 15

 or 

Select Temperature Voltage Output

Enter Setup Mode (see page 3). Press ON repeatedly until the display shows “AO t” (Analog Output Temperature) in the center. See Figure 16. Press ∇ or Δ to set 5 or 10 Volts as the upper end of the output range. Press ON when desired value is displayed.

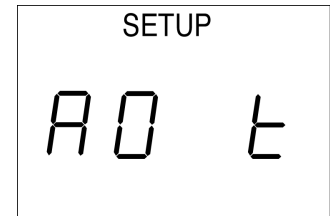





Figure 16

 or 

Set Flow Output Upper Limit

Enter Setup Mode (see page 3). Press ON repeatedly until the display shows “FS F” (Full Scale Flow) in the center. See Figure 17. Press ∇ or Δ to set the upper limit of the flow output. Do not set this value higher than the largest flow value of the meter. Press ON when desired value is displayed.

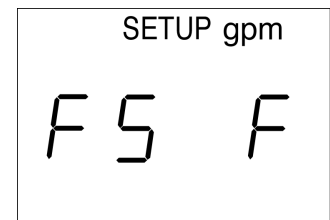





Figure 17

 or 

Set Temperature Output Upper Limit

Enter Setup Mode (see page 3). Press ON repeatedly until the display shows “FS t” (Full Scale Temperature) in the center. See Figure 18. Press ∇ or Δ to set the upper limit of the temperature output. Press ON when desired value is displayed. Setup Mode will continue unless you exit.

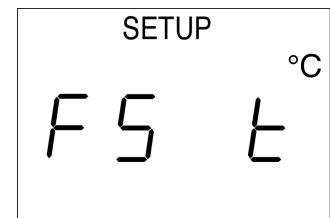

Figure 18

Calibration Mode

Calibration Mode allows the user to adjust the calibration values for flow and temperature. Other functions include LCD self-test. There are eight functions or displays available through this mode. The ON button scrolls the menu through all functions until the user turns the display off.

Start Calibration Mode

hold



then



The display must be off to enter this mode. Press and hold Δ , then press ON. CAL will be displayed. See Figure 19. To scroll through the Calibration Mode, press the ON button. If the ON button is not pushed within three seconds, the display will automatically shut off.

Software Version



By pressing ON once after entering Calibration Mode, the software version will display. See Figure 20. There is no adjustment to be made.

EEPR



This function resets the calibration values to the program defaults. See Figure 21. **Do not reset these values!** This will re-program the Tracer flowmeter back to pre-calibrated settings. The flowmeter must be recalibrated if this is done.

Flow Calibration Value

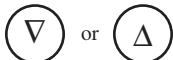

Increase or decrease this number by using the arrow keys. See Figure 22. **Increasing** the calibration value by 20 units **lowers** the flow display by .1 gpm. See the Flow Calibration Procedure below.

Temperature Calibration Value



Increase or decrease this number by using the arrow keys. See Figure 23. **Increasing** the calibration value by 10 units **raises** the temperature display by 1 degree F.

Temperature Slope Calibration Value



Do not adjust.



Figure 19

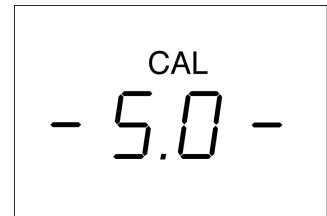

Figure 20



Figure 21

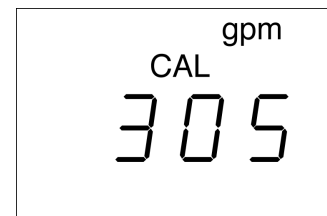

Figure 22



Figure 23

Analog Output Calibration

This calibration compensates the output for tolerances of electronic components. Analog Output Calibration sets the upper end of the temperature and flow output at exactly 10 Volts.

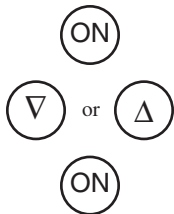

Flow (See Figure 24): Connect the Orange wire to the + side of a voltmeter and the Black wire to ground connection. Adjust the number on the Tracer flowmeter using the arrow buttons until the voltmeter reads exactly 10 Volts. Press the ON button to scroll to the next function.

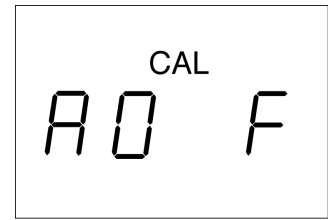

Figure 24

Temperature (See Figure 25): Connect the Violet wire to the + side of a voltmeter and the Black wire to ground connection. Adjust the number on the Tracer flowmeter using the arrow buttons until the voltmeter reads exactly 10 Volts. Press the ON button to scroll to the next function.

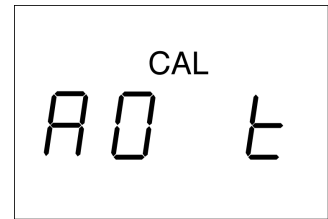
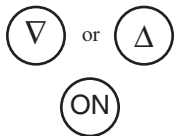

Figure 25

LCD Test Screen



See Figure 26. By pushing either arrow button, "test" will display. By pushing the ON button while "test" is displayed, the LCD will run a self-test. See Figure 27 for LCD diagram.

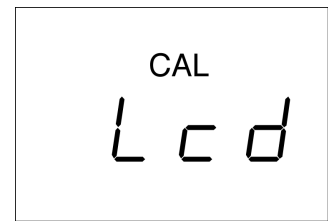
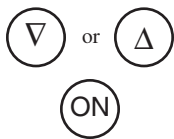

Figure 26

End Screen



By pressing either arrow button the display will change to "OFF". Press the ON button to turn off the display.

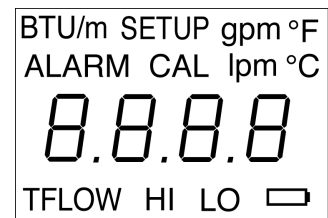

Figure 27

Flow Calibration

Procedure

Tools Required:
 Five Gallon (minimum) Calibrated Container
 Stopwatch
 Valved Water Supply

See Figure 28 for an example of the test configuration.

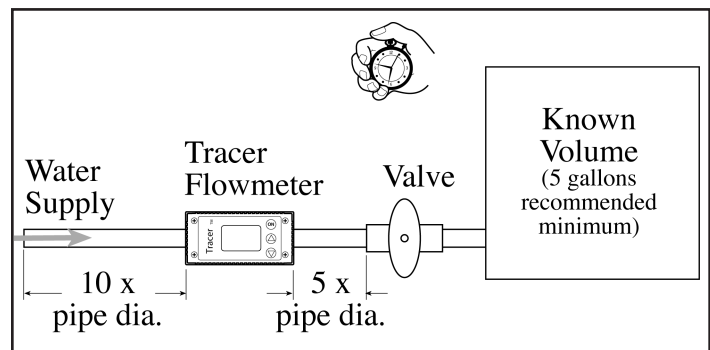

Figure 28

Flow Calibration Procedure (continued)

Before you begin: Purge all the air from the system by running liquid through the test apparatus.

For best results, take readings as close to full range as possible (5 gpm for the 3/8"NPT, etc.).

1. If the display is off, push the ON button on the Tracer flowmeter.
2. Turn valve to full open position quickly and start timer simultaneously.
3. Record flow display on the Tracer flowmeter.
4. When the liquid reaches the selected level in the container, stop timing and close the valve.
5. Divide the volume from the container by time **in minutes** from the timer to determine flow rate.
6. Plug the numbers into the following formula:
Tracer reading - manual reading = difference
Multiply the difference x 200.
7. Add the resulting number (positive or negative) to the Flow Calibration Value in the Calibration Mode. Use the Calibration Mode to change the flow calibration value, as shown on page 7.

Temperature Calibration Procedure

Tools Required:

Accurate Temperature Measuring Device

Water Supply

See Figure 29 for an example of the test configuration.

For best results, temperature calibration should be performed with liquid flowing through the Tracer flowmeter

1. Stabilize the temperature by allowing water to run through the circuit for a few minutes.
2. Press ON on the Tracer Flowmeter, then Δ to display the temperature.
3. Record the temperature shown.
6. Plug the numbers into the following formula:
Measuring device reading - Tracer Flowmeter reading = difference
Multiply the difference x 10.
7. Add the resulting number (positive or negative) to the Temperature Calibration Value in the Calibration Mode. Use the Calibration Mode to change the temperature calibration value, as shown on page 7.

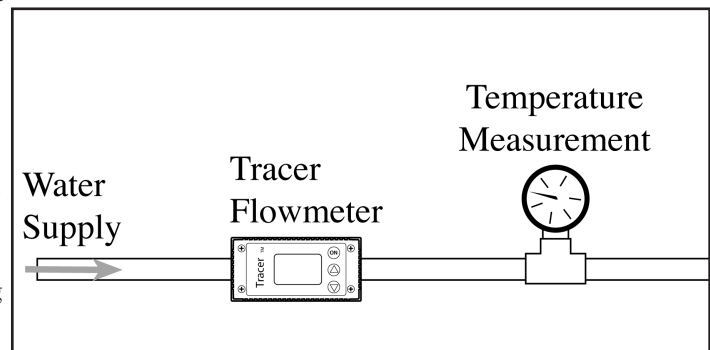

Figure 29

Maintenance Instructions

Calibration

Annual calibration is recommended. Return to the factory for calibration, or follow the Flow and Temperature Calibration Procedures on pages 8 and 9.

Caution: Do not blow compressed air through the flowmeter. Damage to the rotor and shaft may result.

Drain liquid from inside Tracer flowmeter when not in use to prevent build-up of scale and mineral deposits.

Copper Plumbing Alert

DO NOT connect an aluminum body flowmeter directly to copper plumbing. Galvanic corrosion is very likely to occur. Stainless steel body material is strongly recommended for this application. Contact the factory for more information.

EMI/RFI

Electromagnetic Interference or Radio Frequency Interference may impair the proper operation of the Switching Tracer. If the unit unexpectedly turns itself off, check the area around the cable and electronic unit for pumps, heaters and electrical relays that may emit EMI/RFI. Move the cable and electronic housing away from Thermal Control Units, Heater Bands, Pumps, etc. If the problem persists, contact the factory.

Chemical Compatibility

The following is a list of chemicals that are not compatible with the UDEL Polysulfone used in the Tracer Electronic Flowmeter. Contact Burger & Brown Engineering for more detailed information. Please contact us for further information.

Burger & Brown Engineering, Inc.
4500 E 142nd Street
Grandview, MO 64030
Tel: 816-878-6675
Fax: 816-878-6683
www.smartflow-usa.com

Acetone, Methyl Ethyl Ketone	Methylene Chloride Tetrachloroethylene
Benzene	1,1,2,2- Tetrachloroethane
Carbon Tetrachloride	Toluene
Chlorobenzene	1,1,1-Trichloroethane
Chloroform	Trichloroethylene
Cyclohexanone	Xylene
Esters	
Freon TA	

Limited Warranty

Seller warrants that this product supplied will conform to the description herein stated and that the product will be of standard quality. This is the sole warranty made by Seller with respect to this product. Seller expressly disclaims any other express or implied warranties, including, but not limited to, the implied warranty of merchantability and the implied warranty of fitness for a particular purpose. Seller shall not be liable for any cost or damages, whether direct, incidental or consequential, including, but not limited to, any injury, loss or damage resulting from the use of this product, regardless of whether any claim for such cost or damages is based on warranty, contract, negligence, tort or strict liability. The sole liability of Seller is limited to repairing or replacing this product. this warranty shall not apply to any products that have been repaired or altered by anyone other than Seller. The warranty shall not apply to any products subject to misuse due to common negligence or accident, nor to any products manufactured by Seller which are not installed or operated in accordance with the printed instructions of Seller or which have been operated beyond the rated capacity of the goods. Seller states that the product's useful safe life is 5 years. Actual life may vary widely depending on operating environment such as temperature, pressure, and chemical exposure. Users are cautioned to refer to instructions for operating limits and a partial list of incompatible chemicals.

burger & brown engineering
800-764-3518