

# Tracer® Electronic Flowmeter

with FCI (Fluid Characteristic Indication)

Operating Instructions (Ver. 5.1)

## General

The Tracer electronic Flowmeter provides the following information at the touch of a button:

- ◆ Fluid Flow Rate in gallons per minute (gpm) or liters per minute (lpm)
- ◆ Fluid Temperature (in degrees Fahrenheit or Celsius)
- ◆ BTU's per minute
- ◆ Fluid Characteristic Indication (Turbulent Flow or "TFLOW" on display)

## BTU Basics

**To obtain the most accurate BTU calculation, use the Tracer to measure the supply side water temperature (in °F) before installing the Tracer in a cooling water return line.**

BTU's per minute calculation is based on the increase in water temperature times the flow rate. The Tracer Electronic Flowmeter calculates this information based on supply side temperature entered manually. Due to inherent differences in most thermometers, the most accurate BTU calculation will result from using the same thermometer (inside the Tracer) to measure supply and return line temperatures. Record the supply side temperature and enter it using the "Set BTU/m Input Temperature" instructions on page 3.

## Turbulent Flow

"TFLOW" notification appears on the display when Turbulent Flow is likely inside the cooling circuit of the selected size.

Turbulent flow is the mixing and swirling of the water inside a cooling line that provides optimum heat transfer. Water flow rate greater than the point of Turbulent Flow does not provide a proportional benefit.

Turbulent flow tracking allows plant managers to apply mathematical cooling principles to all machines in a water system. Visit the Technical Documents section of [www.smartflow-usa.com](http://www.smartflow-usa.com) for a detailed discussion of Turbulent Flow.

Input the percentage of glycol in cooling water (0%, 10%, 20% or 30%) for accurate Turbulent Flow Indication. See Setup Mode option on page 4. Antifreeze compounds of ethylene or propylene glycol are sometimes added to cooling water. Glycol compounds have substantially higher viscosity than water. As a result, higher flow rates are required to reach Turbulent Flow when glycol is used.

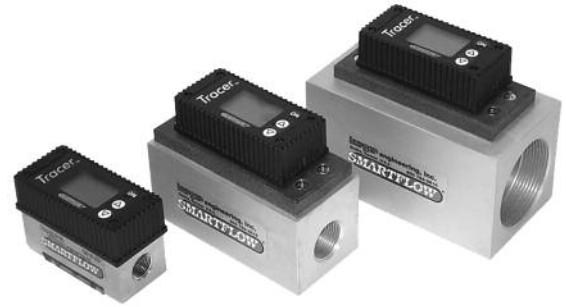

U.S. Patent No. 7,729,869

## Specifications

### Flow

Size	Range (gpm)	Range (lpm)
3/8"	0.5 to 8	2 to 30
3/4"	2.0 to 20	8 to 76
1"	3.0 to 30	11 to 114
1-1/2"	6.5 to 60	25 to 228
2"	10.0 to 110	38 to 418

Accuracy.....±5% of Full Range

Repeatability.....±5% of Full Range

### Temperature

Range.....32 to 180°F  
(0 to 82°C)

Accuracy.....±2% of Display Value

Repeatability.....±1% of Display Value

### Environment

Tracer electronics housing is water resistant, but is not submersible.

### Component Materials

Body (3/8" model).....Nickel-Plated Brass

Body (3/4" thru 2").....Anodized Aluminum or  
Stainless Steel

Back Cover (3/8" only) .....Polysulfone

Impeller.....Nylon 6/12

Magnet.....Neodymium

Shaft.....303 Stainless Steel

Electronics Cover .....Nylon 6/6

### Application

*Liquid running through the Tracer flowmeter should be free of metal shavings. Metal shavings will attach to the sensing magnet in the impeller, causing the unit to require extra maintenance.*

 **Burger & Brown**  
ENGINEERING

4500 E 142nd Street • Grandview, MO 64030 • Tel. (816) 878-6675 • Fax (816) 878-8863 • [www.smartflow-usa.com](http://www.smartflow-usa.com)

## Operating Instructions

There are three modes of operation for the Tracer Electronic Flowmeter: User Mode, Setup Mode, and Calibration Mode. **User Mode** displays all available process information. **Setup Mode** configures the flowmeter for unit selection (°F, °C, lpm, and gpm) and automatic shut off time. Setup Mode also allows you to enter input temperature to calculate BTU's, flow filter on/off, and change pipe size for Turbulent Flow calculation. **Calibration Mode** is used for field calibration and LCD self test. Calibration Mode settings should only be changed with extreme caution.

### User Mode

After pressing ON, press  $\Delta$  or  $\nabla$  buttons repeatedly to scroll continuously through displays of flow rate, temperature and BTU/m. After a few seconds (selectable in the setup mode), the display shuts down automatically to conserve battery power.

#### View Flow Rate

Press ON. Flow rate and units (gpm or lpm) will be displayed. See Figure 1.



#### View Temperature

Press  $\Delta$ . Temperature and units (°F or °C) will be displayed. See Figure 2.



#### View BTU/m (does not display if inactive)

Press  $\Delta$ . BTU's and units will be displayed. See Figure 3. To activate, enter Setup Mode, and follow instructions to set input temperature found on page 3.



Figure 1



Figure 2

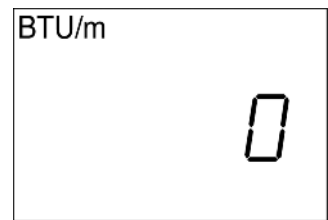

Figure 3

### Setup Mode

Setup Mode allows the user to select English or Metric units, input BTU/m inlet temperature, and set auto shut-off time.  $\Delta$  and  $\nabla$  keys scroll through all options inside each display selection.

#### Enter Setup Mode

The display must be off to enter Setup Mode. Press and hold  $\nabla$ , then press ON. Flow rate units plus "SETUP" and "Unit" will be displayed. See Figure 4.

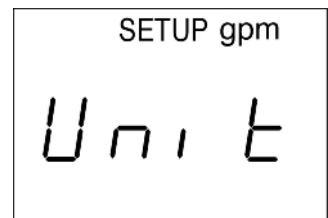
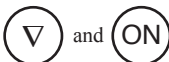
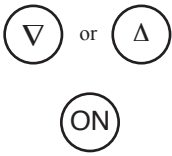

Figure 4

## Setup Mode (continued)

### Select Flow Rate Units



Press  $\nabla$  or  $\Delta$  to change units to gpm or lpm. Press ON when the desired unit is displayed. See Figure 4. Setup mode will continue unless you exit.

### Exit Setup Mode

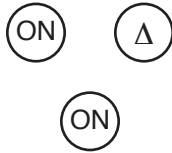

Press ON repeatedly until the display reads “end”, then press  $\Delta$ . See figure 5. The display will read “off”, then press ON and the display will go blank.  
or  
Wait until the display shuts off automatically.

### Select Temperature Units

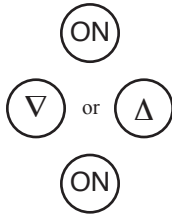

Enter Setup Mode (see page 2). Press ON repeatedly until the display shows “°F” or “°C” in the upper right corner and “unit” in the center. See Figure 6. Press  $\nabla$  or  $\Delta$  to change units. Press ON when desired unit is displayed.  
Setup Mode will continue unless you exit.

### Set BTU/m Input Temperature

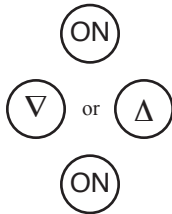

*BTU calculation is available in English units only. See BTU Basics on page 1.*  
Enter Setup Mode (see page 2). Press ON repeatedly until the display shows “BTU/m” in the upper left corner. See Figure 7. Press  $\nabla$  or  $\Delta$  to change input temperature (40 to 180°F). Press ON when desired unit is displayed.  
*Note: If you try to set the temperature input to less than 40°F, the display will show “off” and BTU/m display will deactivate.*  
Setup Mode will continue unless you exit.

### Set Automatic Display Shut-off Time

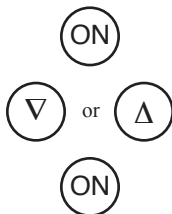

Enter Setup Mode (see page 2). Press ON repeatedly until the display reads “Auto” in the center. See Figure 8. Press  $\nabla$  or  $\Delta$  to change shut-off time (15 to 240 seconds). Press ON when desired shut-off time is displayed. Default value is 60 seconds.  
*Note: if you press  $\nabla$  until the time shut-off goes past 240 seconds, the display will show “off”, and the automatic shut-off feature will deactivate. The display will be off or on until you press ON to change it.*

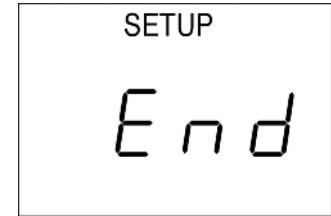

Figure 5

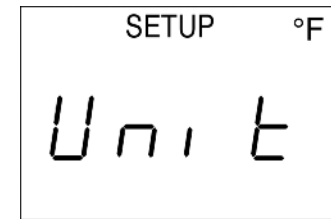

Figure 6

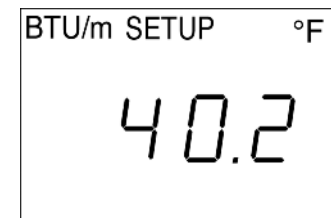

Figure 7

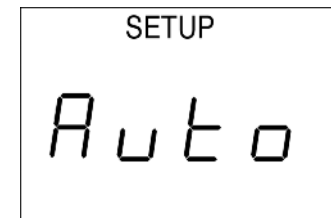

Figure 8

## Setup Mode (continued)

### Reactivate BTU/m or Automatic Display Shut-off Time

Follow the instructions to set (on page 3) and press  $\nabla$  or  $\Delta$  to display a value instead of “off”, and press ON to set.

### Set Flow Rate Display Filter

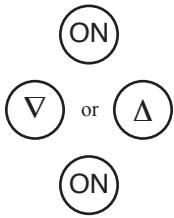

The Tracer flowmeter impeller changes speed as the water is swirling and mixing while passing through the meter. The filter program stabilizes the display reading for the meter by averaging readings from the impeller. Filter can be turned ON or OFF. The recommended setting is ON.

Enter the Setup Mode (see page 2). Press ON repeatedly until the display reads “Filt” (see figure 9) Press  $\nabla$  or  $\Delta$  to toggle the filter setting ON or OFF.



Figure 9

### Change Cooling Line Size (Turbulent Flow)

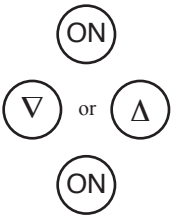

Enter Setup Mode (see page 2). Press ON repeatedly until the display shows “PIPE” (see Figure 10). Press  $\nabla$  or  $\Delta$  to change cooling line size. Available sizes are:

0.250
0.375
0.750
1.000
1.500
2.000

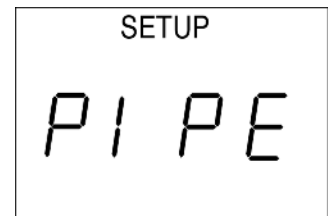
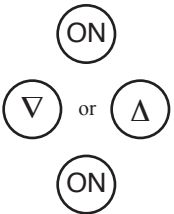

Figure 10

Turbulent flow display “TFLOW” and calculation are adjusted automatically based on process temperature and pipe size.

### Select Percentage of Glycol



Enter the percentage of glycol present for accurate Turbulent Flow “TFLOW” Indication. Higher flow rate is required to achieve Turbulent Flow when glycol is present.

Enter Setup Mode (see page 2). Press ON until the display shows “GLYC” (see Figure 11). Press  $\nabla$  or  $\Delta$  to indicate the correct glycol percentage: 0, 10, 20, or 30%. Press ON to set.

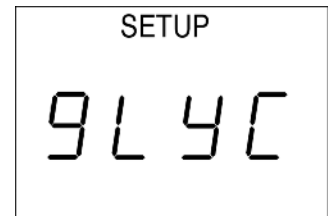

Figure 11

Exit Setup Mode before returning to normal use.

## Calibration Mode

Calibration mode allows the user to adjust the calibration values for flow and temperature. Other functions include LCD self-test, Battery voltage display and low battery warning set point adjustment. There are eight functions or displays available through this mode. The ON button scrolls the menu through all eight functions until the user turns the display off. **The flowmeter will not turn off automatically in this mode. It is very important to turn off the display after using these functions!**

### Start Calibration Mode

hold



then



The unit must be off to enter this mode. Press and hold  $\Delta$ , then press ON. CAL will be displayed. See Figure 12. To scroll through the calibration mode, press the ON button. If the ON button is not pushed within three seconds, the unit will automatically shut off.

### Software Version



By pressing ON once after entering the calibration mode, the software version will display. See Figure 13. There is no adjustment to be made.

### EEPR



This function resets the calibration values to the program defaults. See Figure 14. **It is not recommended to reset these values!** This will reset the Tracer flowmeter to pre-calibrated settings. The flowmeter must be re-calibrated if this is changed.

### Flow Calibration Value



Increase or decrease this number by using the arrow keys. See Figure 15. **Increasing** the calibration value by 20 units **lowers** the flow display by .1 gpm. See the Flow Calibration Procedure on page 6.

### Temperature Calibration Value



Increase or decrease this number by using the arrow keys. See Figure 16. **Increasing** the calibration value by 10 units **raises** the temperature display by 1 degree F. See the Temperature Calibration Procedure on page 7.



Figure 12

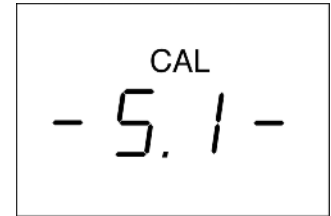

Figure 13

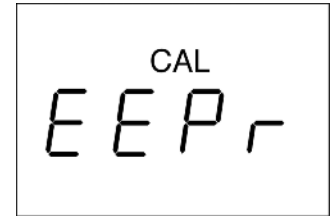

Figure 14



Figure 15



Figure 16

## Calibration Mode (continued)



### Temperature Slope Calibration Value

Do not adjust.

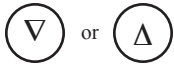

### Low Battery Display and Battery Voltage

Sets the low voltage required to display the low battery message. After three seconds the display automatically shows the actual battery voltage. See Figure 17. Factory setting is 3.00.



Figure 17

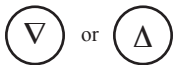

### LCD Test Screen

See Figure 18. By pushing either arrow button, "test" will display. By pushing the ON button while "test" is displayed, the LCD will run a self-test. See Figure 19 for self-test display.

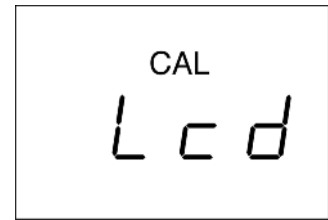

Figure 18



### End Screen

By pressing either arrow button the display will change to "OFF". Press the ON button to turn off the display.

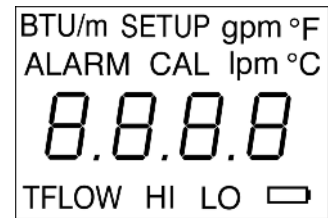
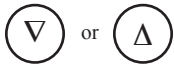

Figure 19

## Flow Calibration

### Procedure

Tools Required:  
 Five Gallon (minimum) Calibrated Container (or weigh on an accurate scale)  
 Stopwatch  
 Valved Water Supply

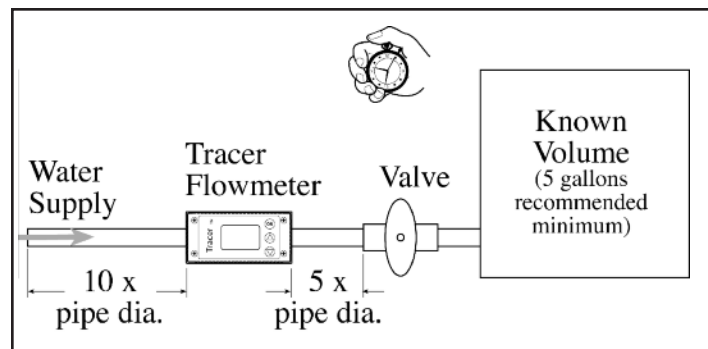

Figure 20

See Figure 20 for an example of the test configuration.

Before you begin: Purge all the air from the system by running liquid through the test apparatus. Set flow display to gpm.

For best results, take readings as close to full range as possible (at least 5 gpm for the 3/8"NPT and 2.5gpm for the 1/4"NPT unit). See page 1 for Range Chart.

## Flow Calibration Procedure (continued)

1. Push the ON button on the Tracer flowmeter.
2. Turn valve to full open position quickly and start timer simultaneously.
3. Record flow rate in gpm shown on the Tracer flowmeter.
4. When the liquid reaches the selected level in the container, stop timing and close the valve.
5. Divide the volume in gallons from the container by time **in minutes** from the stopwatch to determine flow rate in gpm.
6. Plug the numbers into the following formula:  
Tracer reading - manual reading = difference  
Multiply the difference x 200.
7. Add the resulting number (positive or negative) to the Flow Calibration Value in the Calibration Mode. Use the Calibration Mode to change the flow calibration value, as shown on page 5.
8. Verify and repeat calibration if needed.

## Temperature Calibration Procedure

Tools Required:

Accurate Temperature Measuring Device

Water Supply

See Figure 21 for an example of the test configuration. Set temperature display to °F before calibration.

Temperature calibration must be performed with liquid flowing through the Tracer flowmeter.

1. Stabilize the temperature by allowing water to run through the circuit for a few minutes.
2. Press ON on the Tracer Flowmeter, then  $\Delta$  to display the temperature in degrees Fahrenheit.
3. Record the temperature shown.
6. Plug the numbers into the following formula:  
Measuring device reading - Tracer Flowmeter reading = difference  
Multiply the difference x 10.
7. Add the resulting number (positive or negative) to the Temperature Calibration Value in the Calibration Mode. Use the Calibration Mode to change the temperature calibration value, as shown on page 5.
8. Verify that Tracer agrees with calibration thermometer and repeat calibration procedure if needed.

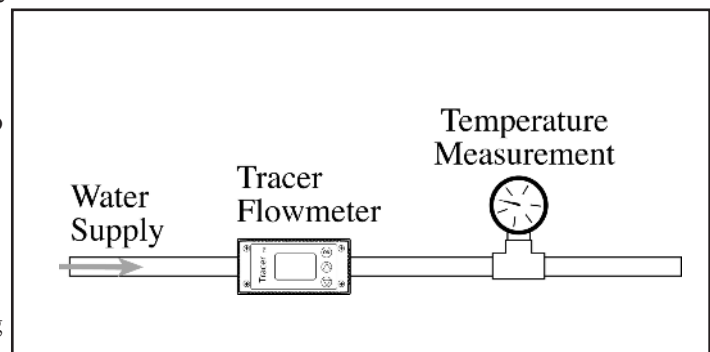

Figure 21

## Maintenance Instructions

### Calibration

Annual calibration is recommended. Return to the factory for calibration, or follow the Flow and Temperature Calibration Procedures on pages 6 and 7.

### Low Battery

Check the display on the Tracer periodically for a low battery message (See Figure 22). When this appears, follow the instructions below.

- Carefully remove the four screws holding down the black molded cover of the Tracer Electronic Flowmeter.
- Replace the battery:

#### Replacement Battery Requirements

Model.....TADIRAN 5902  
 Nominal Voltage.....3.6V  
 Nominal Discharge Current.....1.0mA  
 Cell Size.....1/2AA

- Replace the cover and four screws.

**Caution: Do not blow compressed air through the flowmeter. Damage to the turbine may result.**

Drain liquid from inside Tracer flowmeter when not in use to prevent build-up of scale and mineral deposits.



Figure 22

## Chemical Compatibility

The following is a list of chemicals that are not compatible with the UDEL Polysulfone used in the Tracer Electronic Flowmeter. Contact Burger & Brown Engineering for more detailed information.

Burger & Brown Engineering, Inc.  
 4500 E 142nd Street  
 Grandview, Missouri 64030  
 Tel: 1-800-764-3518  
 Fax: 816-878-6683  
 www.smartflow-usa.com

Acetone, Methyl Ethyl Ketone	Methylene Chloride
Benzene	Tetrachloroethylene
Carbon Tetrachloride	1,1,2,2-Tetrachloroethane
Chlorobenzene	Toluene
Chloroform	1,1,1-Trichloroethane
Cyclohexanone	Trichloroethylene
Esters	Xylene
Freon TA	

## Limited Warranty

Seller warrants that this product supplied will conform to the description herein stated and that the product will be of standard quality. This is the sole warranty made by Seller with respect to this product. Seller expressly disclaims any other express or implied warranties, including, but not limited to, the implied warranty of merchantability and the implied warranty of fitness for a particular purpose. Seller shall not be liable for any cost or damages, whether direct, incidental or consequential, including, but not limited to, any injury, loss or damage resulting from the use of this product, regardless of whether any claim for such cost or damages is based on warranty, contract, negligence, tort or strict liability. The sole liability of Seller is limited to repairing or replacing this product. this warranty shall not apply to any products that have been repaired or altered by anyone other than Seller. The warranty shall not apply to any products subject to misuse due to common negligence or accident, nor to any products manufactured by Seller which are not installed or operated in accordance with the printed instructions of Seller or which have been operated beyond the rated capacity of the goods. Seller states that the product's useful safe life is 5 years. Actual life may vary widely depending on operating environment such as temperature, pressure, and chemical exposure. Users are cautioned to refer to instructions for operating limits and a partial list of incompatible chemicals.

**burger & brown engineering**  
**816-878-6675**